

مشخصات کلی فلومتر

Technical Specification

- Measurement accuracy: $\pm 1\%$
- Velocity range: 0~ ± 10 m/s, forward and reverse measurement
- Pipe diameter: DN15~DN6000
- Fluid temperature: 30~160°C
- Working humidity: $\leq 85\%$ RH (host)
- Working temperature: -20~60°C (host)
-30~160°C (Probe)
- Fluid type: water, sea water, sewage, acid and alkali, alcohol
Beer, various oils, etc. can conduct ultrasonic waves of a single homogeneous liquid
- Pipe material: Steel, stainless steel, cast iron, copper, PVC, fg, FRP, etc., all dense pipes,
Lined allowed
- Signal output: 1 channel 4-20mA current output impedance 0~1K
1 channel OCT pulse output pulse 6~1000ms
1 channel relay output
- Signal input: 3-way 4-20mA current input, can be used as a data collector to connect to a three-wire PT100 platinum resistance to realize heat measurement
- Communication interface: isolated RS485, support MODBUS
- Data storage: SD card regularly stores measurement data (option)
- Power supply:
 - Wall-mounted: DC 8~36V, AC 85~264V
 - Modular type: DC 8~36V
 - Handheld: 3 AAA built-in Ni-H batteries
- Protection class: IP67 (host), IP68 (probe)

Product Host صفحه نمایشگر فلومتر



Ultrasonic Flow Meter



Overview

The ultrasonic flowmeter consists of a host and a sensor.

The flow measurement of various liquids can be completed simply by sticking the clamp-on sensor on the surface of the pipe. Compared with the traditional measuring meter, it does not need to cut off the pipe, the installation is convenient and quick, and the non-destructive installation is truly realized.

The host can be installed on the wall, instrument box, distribution box, and the protection level reaches IP67.

The clamp-on sensor is installed on the surface of the pipeline, and different sensors are selected. The applicable diameter is: DN15~DN6000.

TECHNOLOGY
HOLYKELL®

USER MANUAL
FLOW MEASUREMENT

HOLYKELL.COM

Contents

1. Products Categories.....	2
1.1 Composition of Ultrasonic flow meter	2
1.2 Types of Converters	2
1.3 Types of Flow/Temperature Transducers	3
2. Check Components.....	3
3. Measuring Diagrams	4
4. Converter Installation and Wiring Diagram	5
4.1 Separated Mounting	5
4.2 Fix mounting	8
4.3 Module type	9
5. Transducer Introduction and Wiring Diagram	10
5.1 Clamp on type transducer.....	10
5.2 Insertion type transducer	11
5.3 Inline type transducer	12
6. Display and Operation	13
6.1 Display and keyboard.....	13
6.2 Operation	13
6.3 Menu Details	14
6.4 Quick setup of measured parameters	21
7. Transducers Installation	22
7.1 Choose installation points	22
7.2 Clamp on transducer Installation	24
7.3 Insertion type transducer installation	27
7.4 In-line type transducer installation	32
7.5 Check Installation	33
8. Finish Installation.....	34

Welcome to use the new generation ultrasonic flow meter made of our patented technology. UF2000 Series Ultrasonic Flow/Heat Meters utilize the transit-time principle to measure the velocity of relatively clean liquids in full pipes.

The purpose of this guide is to provide installation procedures and basic operating instructions for UF2000 Series Ultrasonic Flow/Heat Meters.

Installation Procedure

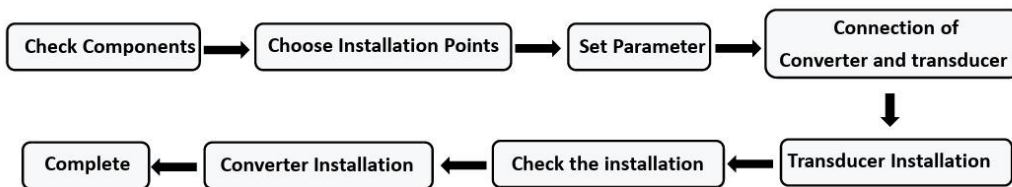







1. Products Categories

1.1 Composition of Ultrasonic flow meter





Ultrasonic Flow meter = Converter + Transducer





Ultrasonic Heat meter = Converter + Transducer + Temperature transducer

1.2 Types of Converters

Items	Separated Mount				Fix Mount UF2000F	Module type UF2000M
	Wall Mount UF2000B	Wall mount UF2000SW	Panel Mount UF2000SS	Explosion proof UF2000SD		
Picture						

1.3 Types of Flow/Temperature Transducers

Flow Transducer	Picture	Model	Measuring range	Temperature
Clamp on		TS-2 (small)	DN32-65	-30 ~ 90°C
		TM-1 (medium)	DN80-400	
		TL-1 (large)	DN450-1000	
High temp. Clamp on		TS-2-HT (small)	DN32-65	-30 ~ 160°C
		TM-1-HT (medium)	DN80-400	
		TL-1-HT (large)	DN450-1000	
Insertion		TC-1 (standard)	DN80-6000	-30 ~ 160°C
		TC-2 (extended)		
		TP-1 (parallel)	DN200-6000	
Inline		Standard	DN15-1000	-30 ~ 160°C

Temperature Transducer	Picture	Model	Measuring range	Temperature	Cutoff water
Clamp on		CT-1	≥ DN50	-40 ~ 160°C	No need
Insertion		TCT-1	≥ DN50	-40 ~ 160°C	Need
Insertion under pressure		PCT-1	≥ DN50	-40 ~ 160°C	No need
Insertion small sizes		SCT-1	< DN50	-40 ~ 160°C	Need

2. Check Components

1. Please check you have all the components in the order.
2. All codes on the converter and transducers should be matched. They are used in sets.

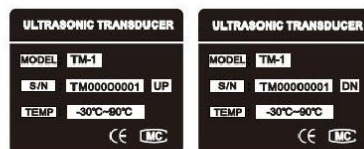



Transducer Codes



Transducer Codes on Converter



3. Measuring Diagrams

3.1 Separated Mounting



		
Clamp on	Insertion	Inline

Note: Mounting of UF2000SS and UF2000SD are in the same way.

3.2 Fixed Mounting

		
Clamp on	Insertion	Inline

3.3 Module type

		
Clamp on	Insertion	Inline

★ Temperature can be measured by connecting PT100 temperature transducer on both supply and return pipes.

4. Converter Installation and Wiring Diagram

4.1 Separated Mounting

● **UF2000B Installation Instruction**

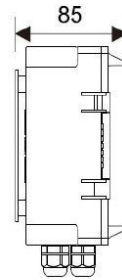
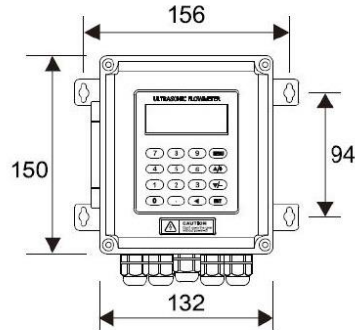

- Wall mounting: Fix the converter with 4 $\Phi 6$ expansion bolts or normal nails.

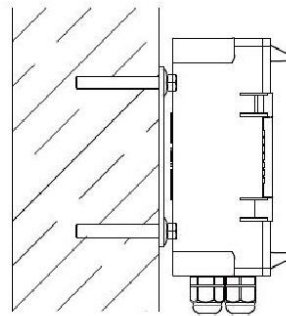
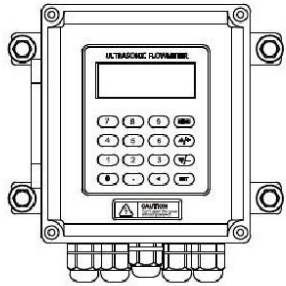

- DIN-rail mounting by using rail fixing clamps.

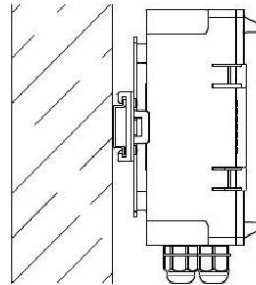
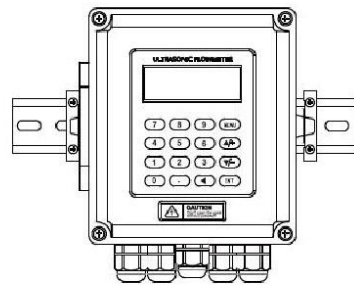

- DIN-rail mounting by using PCB bracket

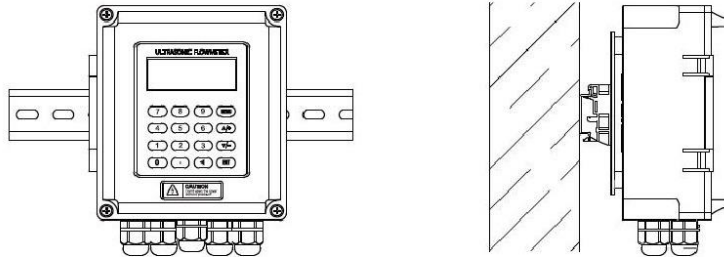

★ Converter of UF2000B can be installed on the wall or in distribution box and explosion-proof box

- UF2000B Wiring Diagram

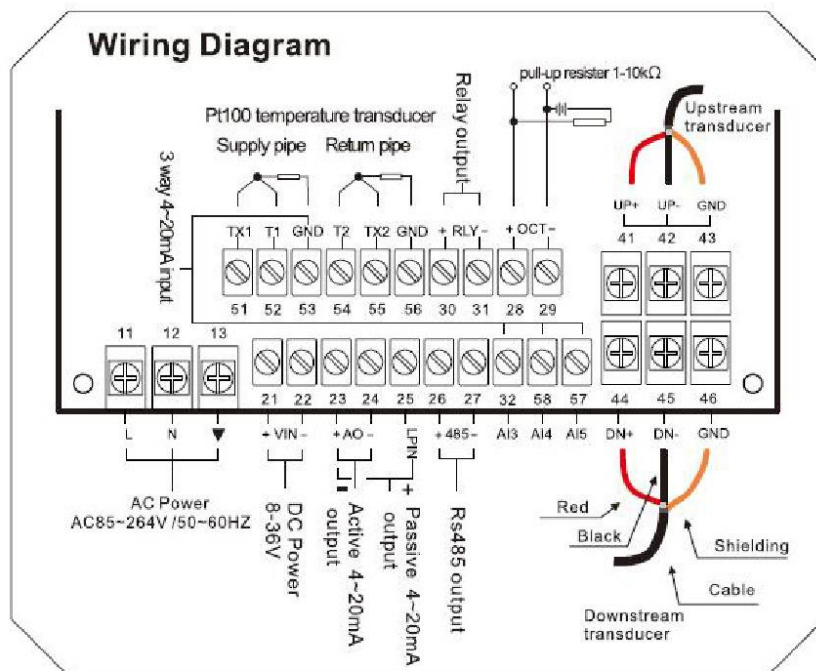

- UF2000SW and UF2000SD Installation Instruction

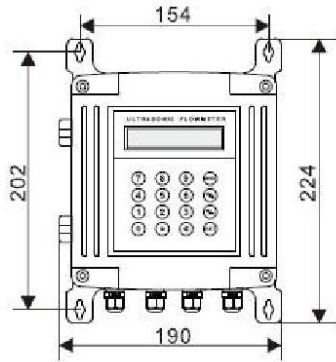

Thickness: 75mm

Wall mounting: Fix the converter with 4 Φ 6 expansion bolts.

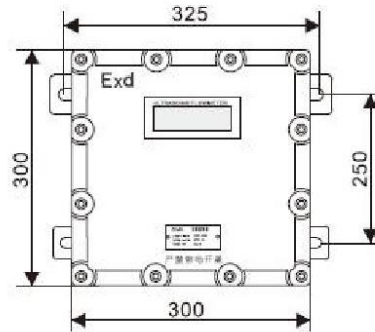

Thickness: 165mm

Explosion-proof grade: D II BT5
Fix the converter with 4 Φ 8 expansion bolts.

● UF2000SW and UF2000SD Wiring Diagram

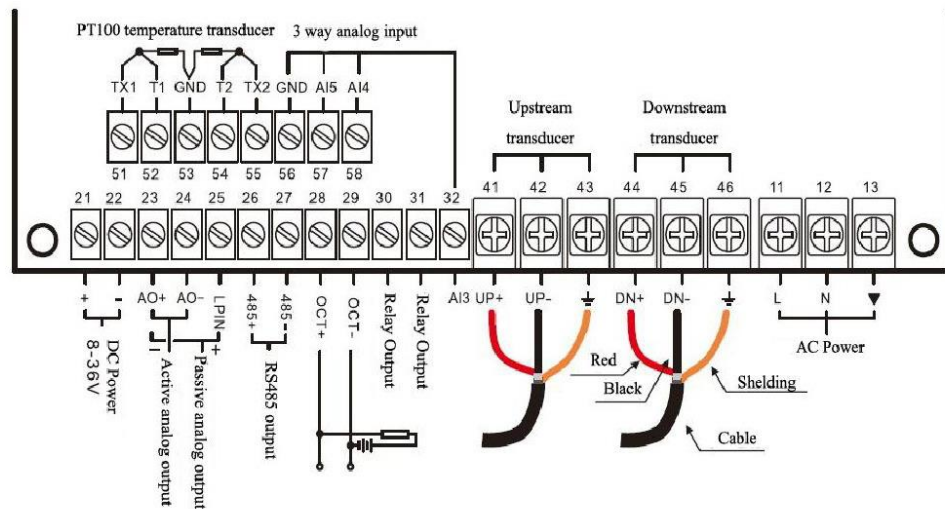

● UF2000SS Installation and Wiring Diagram

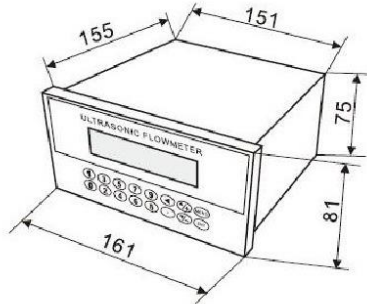

RS485		4-20mA			Upstream sensor			Downstream sensor		
+	-	+	-	UP+	UP-	GND	DN+	DN-	GND	
L	N	⊥	TX2	T2	GND	T1	TX1	+	-	
AC Power 220V			Supply water		Return water		OCT			
PT100 temperature sensor										

- Used for Panel Mounting
Hole size : 152 × 76mm

4.2 Fix mounting

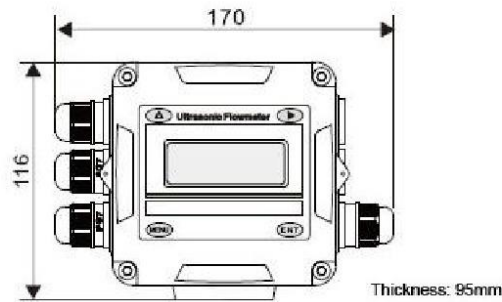

The converter is generally installed on the pipeline, sometimes installed on the wall of a well to avoid water immersion.

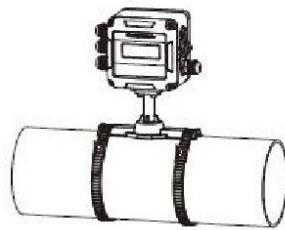

Install on pipeline

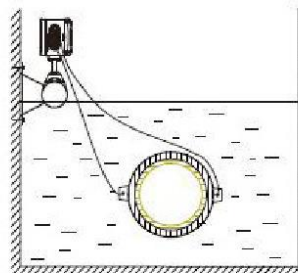

Install on the wall of a well

- UF2000F Wiring Diagram

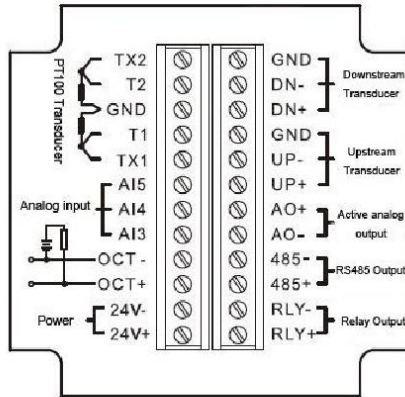

Open the back cover and complete the wiring. To avoid leaking, please tighten the water joint and screws of the back cover after wiring. Be sure not to open the front cover.

4.3 Module type

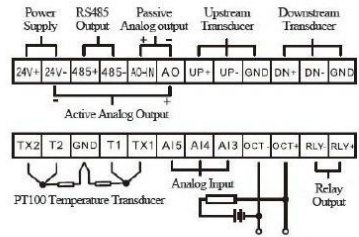
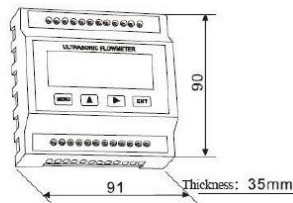

Installation

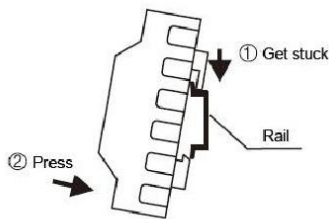

- ① Get the above slot stuck in the rail.
- ② Press the bottom of converter to make it totally stuck in the rail.

Remove

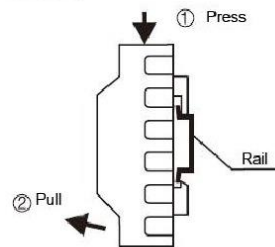

- ① Press the converter top hard
- ② Outward pull the bottom part

5. Transducer Introduction and Wiring Diagram

5.1 Clamp on type transducer

- Introduction

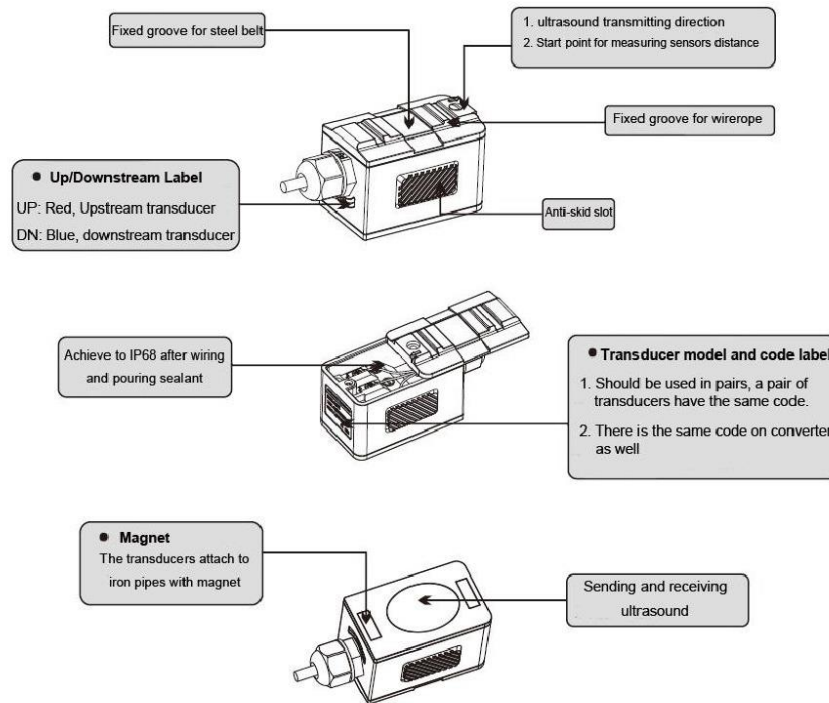

- Wiring Diagram

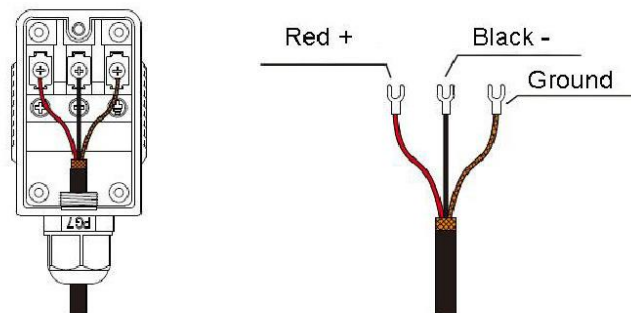

5.2 Insertion type transducer

● Introduction

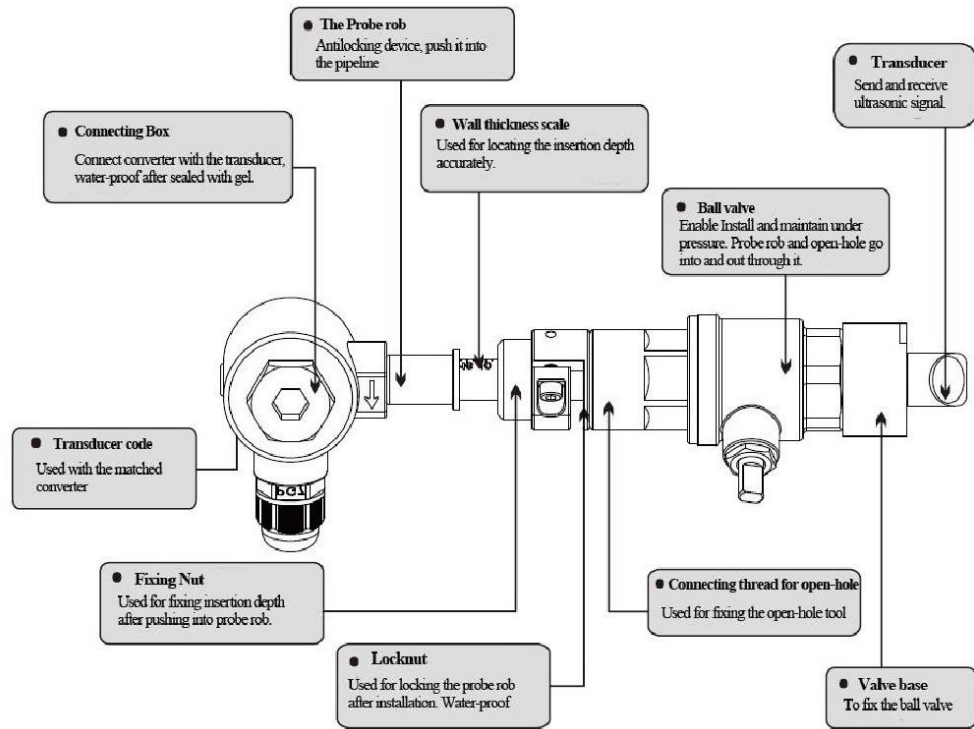

● Wiring Diagram

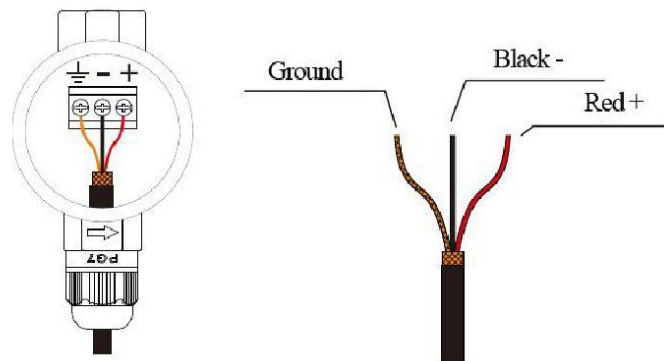

5.3 Inline type transducer

- Introduction

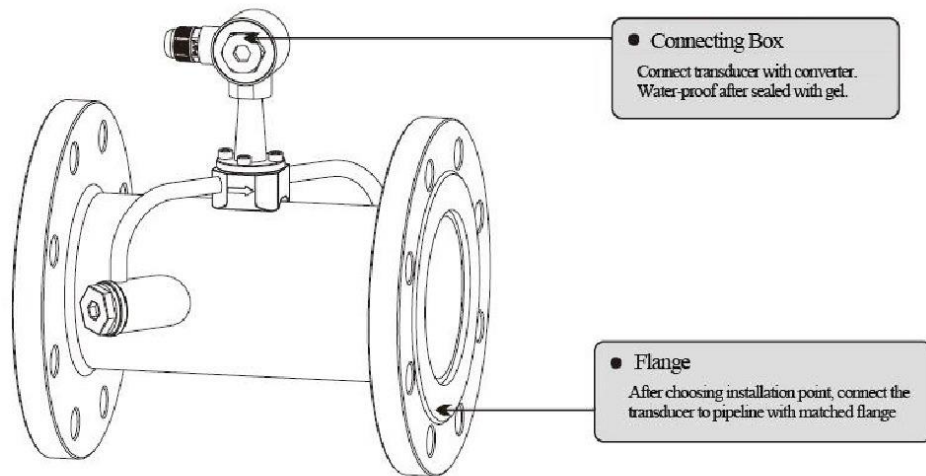

- Wiring Diagram

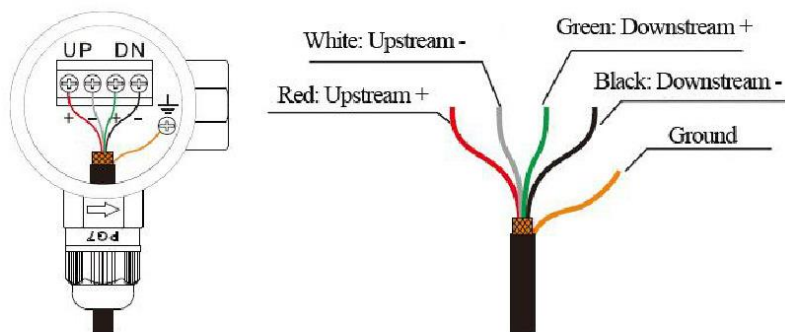

6. Display and Operation

6.1 Display and keyboard

Display is 2×20 characters LCD with backlight, available to set backlight time and contrast.

- 16-key Keyboard

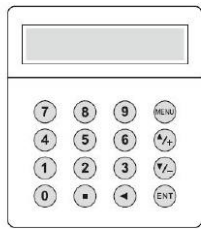

Separated Mounting

0 - 9 and . are used for inputting numbers or menu numbers.

◀ is used for back left or delete the left character.

▲/+ and ▼/- are used for entering into the last and next menu. Also can be used as ± sign when inputting numbers.

MENU is used for accessing the menu. Press this key first, then type the number keys to enter into the matched menu.

ENT is the ENTER key, used for confirming the contents you input or choose.

- 4-key Keyboard

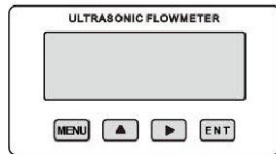

UF2000M

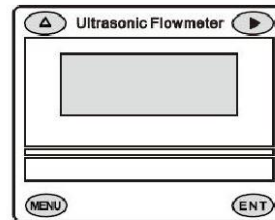

UF2000F

MENU : used for entering into menus.

▲ : used for menu up or choosing 0-9, +, -

▶ : used for menu down or moving the cursor to next.

ENT : used for finishing menu inputting or entering into sub menu.

6.2 Operation

The user interface of this flow meter comprises about 100 different menu windows that are numbered by M00, M01, M02 ... M99.

Method to enter Menu: Press MENU first, and follow the two-digit number keys. Take M35 as an example, the correct key sequence is MENU 3 5

To move between the adjacent menus, press ▲/+ and ▼/- for 16-key keyboard; press ▲ and

▶ for 4-key keyboard.

6.3 Menu Details

Menu No.	Details
M00	Display flow rate and NET totalizer. Unit selection in M30~M32.
M01	Display flow rate and velocity. Unit selection in M30~M32.
M02	Display flow rate and POS(positive) totalizer. Unit selection in M30~M32.
M03	Display flow rate and NEG(negative) totalizer. Unit selection in M30~M32.
M04	Display date and time, flow rate.
M05	Display heat flow rate and total heat. Unit selection in M84 and M88.
M06	Display temperatures, inlet T1, outlet T2
M07	Display analog inputs, AI3/AI4
M08	Display system error codes. 'R' stands for normal.
M09	Display today's total NET flow
M10	Input outer perimeter.
*M11	Input outer diameter. Available range is 0 to 18000mm.
*M12	Input pipe wall thickness
*M13	Input inner diameter.
*M14	Select pipe material.
M15	Input sound velocity of the pipe material.
M16	Select lining material.
M17	Input sound velocity of the lining material.
M18	Input the lining thickness.
M19	Input the absolute roughness of pipe inner wall.
*M20	Select the liquid type.
M21	Input sound velocity of the liquid.
M22	Input viscosity of the liquid.
*M23	Select the transducer type. Over 20 types can be selected.
*M24	Select the mounting method of transducer.
*M25	Display the transducer mounting distance.
*M26	<p>0 Use RAM setting: A switch for the parameters in flash memory will be loaded when power is turned on. The default option is that the parameters will be loaded. If this switch is not turned on, the system will try to use the parameters in the system RAM, if these parameters are ok, otherwise the system will load the parameters in flash memory</p> <p>1 Solidity setting: Function to store the current parameters into the flash memory, so that these parameters will be solidified and will be loaded as the default parameters every time when power is turned on.</p>
M27	To save the installation point parameter.
M28	Maintain the last good value when poor signal condition occurs. YES is the default setup.
M29	Setup a signal strength as empty pipe. For example input 65, it means the pipe is treated

	as empty pipe when the signal is less than 65, and the flow rate display is 0.
M30	Select metric or British system unit.
M31	Select flow rate unit.
M32	Select totalizer flow unit.
M33	Select totalizer multiple factor. The multiplying factor ranges from 0.001 to 10000. Factory default is 1
M34	Turn on or turn off the NET totalizer
M35	Turn on or turn off the POS (positive) totalizer
M36	Turn on or turn off the NEG(negative) totalizer
M37	Restore factory settings. Totalizer reset.
M38	Manual totalizer used for easier calibration. Press a key to start and press a key to stop the manual totalizer.
M39	Language selection. there are Chinese+English+Italian or English+Italian+Turkish
*M40	Damping factor. The damping factor ranges from 0 to 999 seconds. 0 means there is no damping. Factory default is 10 seconds
*M41	Cut-off low flow rate (or zero flow rate) to avoid invalid accumulation.
M42	Zero calibration/Zero point setup. Make sure the liquid in the pipe is not running while doing the setup.
M43	Clear the zero point value, and restore original value.
M44	Manual Zero point . Set up a flow bias. Generally this value should be 0.
M45	Flow rate scale factor. The default value is '1'. Keep this value as '1', when no calibration has been made.
M46	Networks address identification number. Any integer can be entered except 13(ODH, carriage return), 10 (0AH, line feeding), 42 (2AH), 38, 65535. Every set of the instrument in a network environment should have a unique IDN. Please refer to the chapter for communication.
M47	System locker to avoid modification of the system parameters. If password is forgotten, you could send a command 'LOCK0' to the serial input to unlock. Or you can write 0 to REGISTER49-50 under MODBUS protocol.
M48	Entry to linearity correcting data inputs. By using of this function, the non-linearity of flow meter will be corrected. Correcting data shall be obtained by careful calibration.
M49	Displays the input contents for the serial port. By checking the displays, you can know if the communication is ok.
M50	Switches for the built-in data logger. There are as many as 22 different items can be chosen. To turn this function, select 'YES' the system will ask for selecting the items.
M51	Time set for timing output.(data logger or printer)
M52	Data logging direction control. (1) If 'Send to RS485' is selected, all the data produced by the data logger will be transmitted out through the RS-232/RS485 interface (2) If 'To the internal serial BUS is selected, the data will be transmitted to the internal serial bus which allows a thermal printer, or a 4-20mA analog output module, to be connected to it.
M53	Display analog inputs, AI5, current value and its corresponding temperature or pressure or liquid level value.

M54	Pulse width setup for the OCT (OCT1) output. Range from 6 mS to 1000 mS
M55	Select analog output (4-20mA current loop, or CL) mode.
M56	Set the value which corresponds to 4mA or 0mA output current (4mA or 0mA is determined by the setting in M55)
M57	Set the value which corresponds to 20mA output current
M58	Current loop verification Check if the current loop is calibrated correctly.
M59	Display the present output current of current loop circuit.
M60	Setup system date and time. Press ENT for modification.
M61	Display Version information and Electronic Serial Number (ESN) that is unique for each flow meter.
M62	RS-232/RS485 setup. All the devices connected with flow meter should have matched serial configuration.
M63	Select communication protocol. Factory default is 'MODBUS ASCII. this is a mode for MODBUS-ASCII, Meter-BUS, Fuji Extended Protocol, Huizhong's various protocols. If you are going using MODBUS-RTU you have to select 'MODBUS_RTU'.
M64	AI3 value range. Used to enter temperature/pressure values that are corresponding to 4mA and 20mA input current. The display values have no unit, so that they can present any physical parameter.
M65	AI4 value range. Used to enter temperature/pressure values that are corresponding to 4mA and 20mA input current.
M66	AI5 value range. Used to enter temperature/pressure values that are corresponding to 4mA and 20mA input current.
M67	Setup the frequency range (lower and upper limit) for the frequency output function. Valid range is 0Hz-9999Hz. Factory default value is 0-1000 Hz.
M68	Setup the minimum flow rate value which corresponds to the lower frequency limit of the frequency output.
M69	Setup the maximum flow Rate value that corresponds to the upper frequency limit of the frequency output.
M70	LCD display backlight control.
M71	LCD contrast control.
M72	Working timer. It can be cleared by pressing ENT key, and then select YES.
M73	Window to setup the lower limit of flow rate for Alarm#1. When the flow rate is below the set value, Alarm#1 equals 'on'
M74	Window to setup the upper limit of flow rate for Alarm#1. When the flow rate is above the set value, Alarm#1 equals 'on' There are two alarms in the flow meter, and every alarm can be pointed to alarm output devices such as the BUZZER or OCT output or RELAY output. For example, if you want the Alarm#1 is to output by the OCT circuit, you need to set M78 at selection item 6.

M75	Window to setup the lower limit of flow rate for Alarm#2.
M76	Window to setup the upper limit of flow rate for Alarm#2.
M77	Buzzer setup. If a proper input source is selected, the buzzer will beep when the trigger event occurs.
M78	OCT (Open Collect Transistor Output)/OCT1 setup By selecting a proper input source, the OCT circuit will close when the trigger event occurs.
M79	Relay or OCT2 setup By selecting a proper input source, the RELAY will close when the trigger event occurs
M80	<p>Window for selecting the trig signal for the built-in batch controller. Available trig sources:</p> <ul style="list-style-type: none"> 0. Key input (press ENT key to start the batch controller) 1. Serial port 2. AI3 rising edge (when AI3 receives 2mA or more current) 3. AI3 falling edge (when AI3 stop receiving 2mA or more current) 4. AI4 rising edge (when AI3 receives 2mA or more current) 5. AI4 falling edge (when AI3 stop receiving 2mA or more current) 6. AI5 rising edge (when AI3 receives 2mA or more current) 7. AI5 falling edge (when AI3 stop receiving 2mA or more current) 8.Timer periodically (define the start time and interval time in M51) 9.Timer daily (define the start time and interval time in M51) <p>For the input analog current signal, 0 mA indicates "0", 4mA or more indicates '1'.</p> <p>By selecting item #8, the batch totalizer can be started periodically by the internal timer located at Menu51. When the batch totalizer is full, a signal which indicate the batch is full can be direct to either the OCT or the RELAY terminals to stop the pump or other devices.</p> <p>By selecting item #9, the batch totalizer could act as totalizer witch runs for only a period of the day so that a alarm signal could be produced if the total flow during that time period is over a certain amount of. For example, if you want a alarm signal which stand for the total flow is over 100 cubic meters during the period of every day from 20:00 to 06:00, setups is like</p> <p>M51 start time =20:00:00 M51 interval =10:00:00 M51 log times =9999 (means always) M80 select item #9 M81 input 100 (Unit is defined in M30,M31,M32)</p>
M81	<p>The built-in batch controller Set the flow batch value(dose) The internal output of the batch controller can be directed either to the OCT or the RELAY output circuits. M81 and M80 should be used together to configure the batch controller. Note: Because the measuring period is 500mS, the flow for every dos should be keeping at 60 seconds long to get a 1% dose accuracy.</p>
M82	View the daily, monthly and yearly flow totalizer and thermal energy totalizer value.

	The totalizer values and errors for the last 64 days, 32 last 32 months and last 2 years are stored in the RAM memory, To view them, use the 'ENT' and 'UP' 'Down' keys.
M83	Automatic Amending Function for automatic offline compensation. Select 'YES' to enable this function, select 'NO' to disable it. When the function is enabled, The flow meter will estimate the average flow uncounted (or 'lost') during the offline session and add the result to the totalizer. The estimation of the uncounted flow is made by computing the product of the offline time period and the average flow rate, which is the average of the flow rate before going offline and the one after going on line.
M84	Set the thermal energy unit: 0. GJ 1. KC 2.KWh 3. BTU
M85	Select temperature sources 0. from T1,T2 (factory default) 1. from AI3,AI4
M86	Select the Specific Heat Value. Factory default is 'GB'. Under this setting, the flow meter will calculate the enthalpy of water based on the international standard. If the fluid is other than water, you should select option '1. Fixed Specific Heat', and enter the specific heat value of the fluid.
M87	Turn on or turn off the Energy totalizer.
M88	Select thermal energy totalizer multiplying factor. Factory default is '1'.
M89	1. Display the temperature difference 2. Window for entering the lowest temperature difference.
*M90	Display signal strengths S (one for upstream and one for downstream), and signal quality Q value. Signal strength is presented by 00.0 to 99.9, the bigger the value, the bigger the signal strength will be, and more reliable readings will be made. Q value is presented by 00 to 99, the bigger the better. It should at least be great than 50 for normal operations.
*M91	Displays the Time Ratio between the Measured Total Transit Time and the Calculated time. If the pipe parameters are entered correctly and the transducers are properly installed, the ratio value should be in the range of 100±3%. Otherwise the entered parameters and the transducer installation should be checked.
M92	Displays the estimated fluid sound velocity. If this value has an obvious difference with the actual fluid sound speed, pipe parameters entered and the transducer installation should be checked again.
M93	Displays total transit time and delta time(transit time difference)
M94	Displays the Reynolds number and the pipe factor used by the flow rate measurement program. Pipe factor is calculated based on the ratio of the line-average velocity and the cross-section average velocity.
M95	(1) Display the positive and negative energy totalizers (2) Upon entering this window, the circular display function will be started automatically. The following windows will be displayed one by one, each window will

	stay for 8 seconds: M95>>M00>>M01>>M02>>M02>>M03>>M04>>M05>>M06>>M07>>M08>>M90>>M91>>M92>>M93>>M94>>M95. This function allows the user to visit all the important information without any manual action. To stop this function, simply press a key. Or switch to a window other than M95.
M96	This is not a window but a command for the thermal printer to advance 5 lines of paper.
M97	This is not a window but a command to print the pipe parameters. By default, the produced data will be directed to the internal serial bus (thermal printer). You can also direct those data to the serial communication port.
M98	This is not a window but a command to print the diagnostic information. By default, the produced data will be directed to the internal serial bus (thermal printer). You can also direct those data to the serial communication port.
M99	This is not a window but a command to copy the current display window. By default, the produced data will be directed to the internal serial bus (thermal printer). You can also direct those data to the serial communication port. By use of the window copying function, you can hardcopy very window displaying manually by switching windows, or you can obtain the window displaying data by communication.
M+0	Browse the 32 recorded instrument power-on and power-off date and time with the flow rate at the time of power on and off
M+1	Displays the total working time of the flow meter. When the backup battery is removed, the total working time will be reset to zero.
M+2	Displays the last power-off date and time
M+3	Displays the last power-off flow rate
M+4	Displays how many times of has been powered on and powered off.
M+5	A scientific calculator for the convenience of field working. All the values are in single accuracy. The calculator can be used while the flow meter is conducting flow measurement. Water density and PT100 temperature can also be found in this function.
M+6	Set fluid sound speed threshold Whenever the estimated sound speed (displayed in M92) exceeds this threshold, an alarms signal will be generated and can transmitted to BUZZER or OCT or RELAY. This function can used to produce an alarm or output when fluid material changes.
M+7	Displays total flow for this month(only for the time past)
M+8	Displays total flow for this year(only for the time past)
M+9	Display the not-working total time in seconds. The total failure timer will also include the time when power off, if the back-up battery is applied.
M.2	Entry to solidify the zero point. Password protected.
M.5	Setup the Q value threshold. If the present Q is below this threshold, flow rate will be set to 0. This function is useful when flow meter is installed in noisy environment or on airy pipes.
M.8	The maximum flow rates for today and this month.
M.9	Serial port tester with CMM command output for very second.

M-0	Entry to hardware adjusting windows only for the manufacturer
M-1	4-20mA output adjustment
M-2	4mA calibration for AI3 input
M-3	20mA calibration for AI3 input
M-4	4mA calibration for AI4 input
M-5	20mA calibration for AI4 input
M-6	4mA calibration for AI5 input
M-7	20mA calibration for AI5 input
M-8	Lower Temperature Zero setup for the PT100
M-9	Higher Temperature Zero setup for the PT100
M-A	Temperature Calibration at 50 °C
M-B	Temperature Calibration at 84.5 °C

6.4 Quick setup of measured parameters

Accurate measured parameters can have a great influence on measuring precision and reliability. It is suggested to measure the practical perimeter and wall thickness of the pipeline. Ultrasonic thickness gauge can be used to measure the pipe thickness.

Measured parameters setup is from Menu10 to Menu29. Please complete one by one.

>>> **Following parameters need to be inputted before measurement:**

1. Outer diameter unit: mm
2. Pipe thickness unit: mm
3. Pipe material
4. Lining parameters: thickness and sound velocity (If have lining)
5. Liquid type
6. Transducer type
7. Transducer mounting type

>> **Above parameters setup generally follow the steps below:**

1. Press keys **[MENU]** **[1]** **[1]** to enter M11 window to input the pipe outer diameter, and then press **[ENT]** key.
2. Press key **[▼/]** to enter M12 window to input the pipe outer diameter and then press **[ENT]** key.
3. Press key **[▼/]** to enter M14 window, and press **[ENT]** key to enter the option selection mode. Use keys **[▲/+]** and **[▼/]** to select the pipe material, and then press **[ENT]** key.
4. Press key **[▼/]** to enter M16 window, press **[ENT]** key to enter the option selection mode. Use keys **[▲/+]** and **[▼/]** to select the liner material, and then press **[ENT]** key. Select “No Liner” , if there is no liner.
5. Press key **[▼/]** to enter M20 window, press **[ENT]** key to enter the option selection mode. Use keys **[▲/+]** and **[▼/]** to select the proper liquid, and then press **[ENT]** key.
6. Press key **[▼/]** to enter M23 window, press **[ENT]** key to enter the option selection mode. Use keys **[▲/+]** and **[▼/]** to select the proper transducer type, and then press **[ENT]** key.
7. Press key **[▼/]** to enter M24 window, press **[ENT]** key to enter the option selection mode. Use keys **[▲/+]** and **[▼/]** to select the proper transducer mounting method, and then press **[ENT]** key.
8. Press key **[▼/]** to enter M25 window and get the transducer installation distance.
9. Press **[MENU]** **[2]** **[6]** to store the parameters setup.

7. Transducers Installation

7.1 Choose installation points

Proper installation point is a key for transducer installation. Following factors must be considered: Full filled pipeline, shaking, steady flow, scaling, temperature, pressure, EMI, instrument well.

>> Full filled pipeline

Following situations can be full filled of liquid:

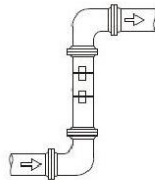

Vertical upward

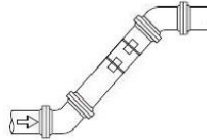

Obliquely upward

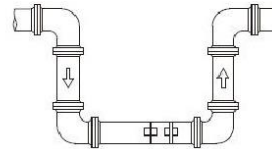

Lowest point

>> Shaking

There cannot be obvious shaking on the installation point, otherwise it needs to be tightened.

>> Steady flow

Steady flow is helpful for ensuring measurement accuracy.

Standard requests for steady flow are:

1. The pipe should be far away from pump outlet and half-open valve.
10D to upstream and 50D to downstream. (D means outer diameter)
2. 30D to pump outlet and half-open valve.

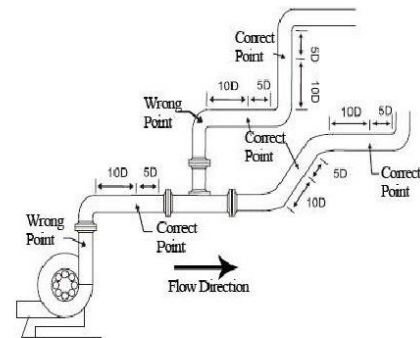
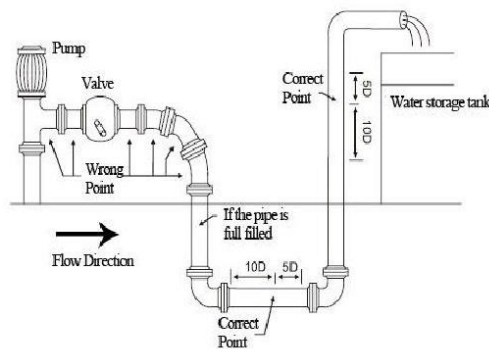

>> Scaling

The inside scaling would have bad effect on ultrasonic signal transmission, and would decrease the inner diameter as well. As a result, the measurement accuracy can not be guaranteed. Please try to avoid choosing the installation point with inside scaling.

>>Temperature

The liquid temperature on installation point should be in the working range of transducers. Please try to choose the point with lower temperature. Avoid to choose points like the outlet of boiler water and heat exchanger. Return water pipe would be better.

Temperature range of standard clamp on and insertion transducers: $-30 \sim 90^{\circ}\text{C}$

Temperature range of high temperature clamp on and insertion transducers: $-30 \sim 160^{\circ}\text{C}$

>>Pressure

The maximum pressure for standard insertion and inline transducer is **1.6MPa**

Out of this range need customized.

>>EMI (electromagnetic interference)

The ultrasonic flow meter, transducer and signal cable can be easily interfered by interference sources such as frequency changer, radio station, microwave station, GSM base station and high-tension cable. Please try to avoid these interference sources when choosing installation points.

The shield layer of flow meter, transducer and signal cable should be connected to earth.

Better to use isolated power supply. Do not use the same power supply with the frequency converter.

>>Instrument well

When measuring underground pipes or need to protect the measuring points, an instrument well is required. To ensure the enough installation space, the sizes of instrument well should meet the following requirements.

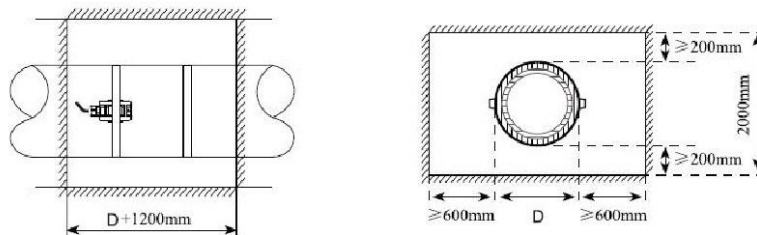

D means the pipe diameter

7.2 Clamp on transducer Installation

⚠ Before installation, please verify the parameters of pipeline and liquid. To ensure the installation accuracy.

1) Installation procedure

Select an installation method → Input the measuring parameters → Clean pipe surface → Install transducers → Check the installation

2) Select an installation method

There are two different methods for clamp on transducers: V method and Z method.

>> V method

V method should be priority selected for pipe sizes DN15 - DN200. Let the pair of transducers horizontal alignment, the central line in parallel with the pipeline axis.

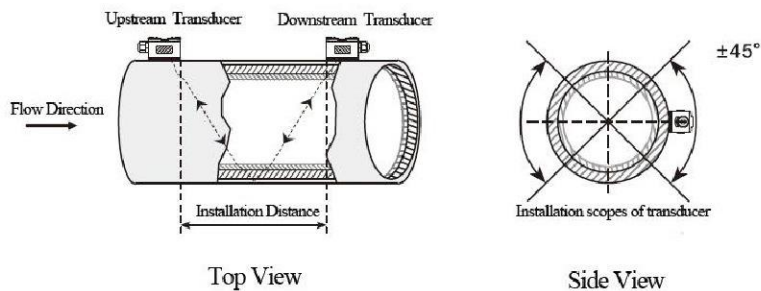

>> Z method

Z method should be priority selected for pipe sizes DN200 - DN6000. Also can be used when V method doesn't work well. Make sure the vertical distance of two transducers equals to the installation distance, and the two transducers are on the same axis surface.

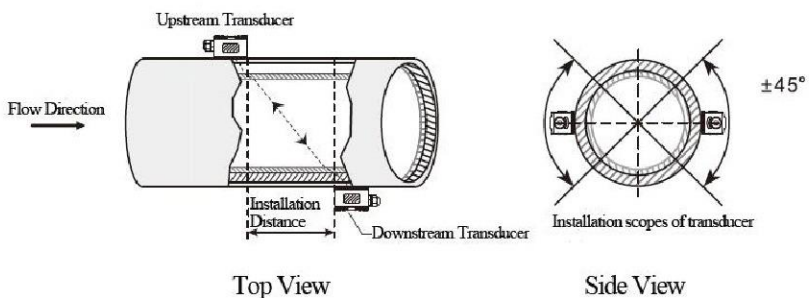

3) Positioning installation points

>> V method

The line between two transducers is parallel to pipe axis, and equal to the distance shown in the converter. As shown, A, B are the two installation points.

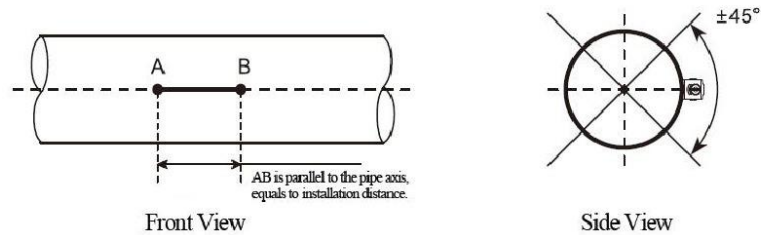

>> Z method

- ① Firstly according to the installation distance shown in converter, positioning two points A, C on the same side of pipeline. AC is parallel to pipe axis.
- ② Perpendicular to the pipe axis, opposite to point C, get Point B.
- ③ Check. Measure the length between A and B from both sides of the pipe, get AB_1 and AB_2 . If $AB_1 = AB_2$ then B is the correct point. If not, need to positioning point B and C again.
As shown, A, B are the two installation points.

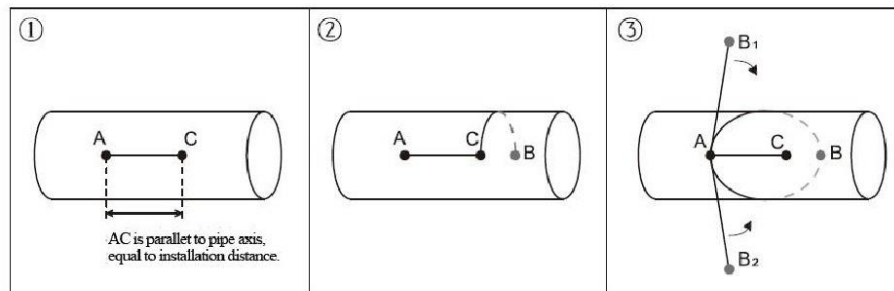

4) Clean the surface of installation points

Paint, rust and anticorrosive coating on installation points need to be cleaned. It's good to use a polishing machine to get the metal luster.

As shown below:

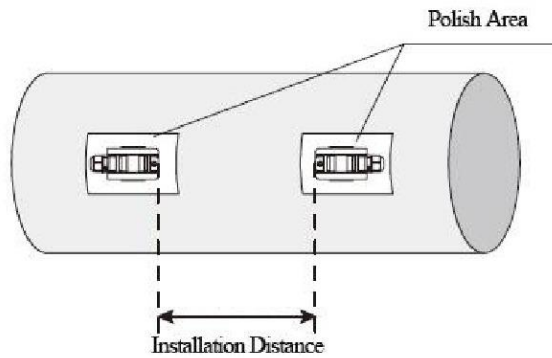

5) Install transducers

After transducer wiring and sealing, please evenly smear 2-3mm couplant on the transducer emitting surface. Then put the transducers on the installation points, fixed with steel belt or steel rope.

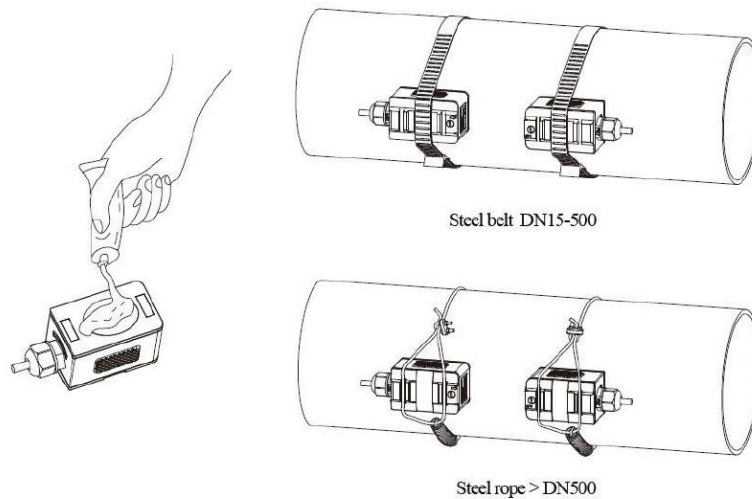

6) Check Installation

Please see details in Chapter 7.5

7.3 Insertion type transducer installation

⚠ Before installation, please verify the parameters of pipeline and liquid. To ensure the installation accuracy.

1) Installation procedure

Select an installation method → Input the measuring parameters → Positioning installation points → Fix ball valve base → Open hole under pressure → Install transducers → Check the installation

2) Select installation method and positioning installation points

Insertion type transducers are suitable for pipe sizes > 50mm.

Two different installation methods: V method and Z method. Generally use Z method, only use V method for lack of space.

>> V method

V method can be used for DN50mm - 300mm. Let the pair of transducers horizontal alignment, the central line in parallel with the pipeline axis, and the transmit direction must be opposite.

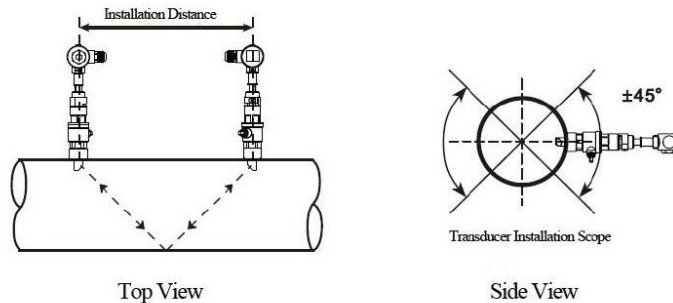

>> Z method

Z method can be used for all pipes > DN50mm. Make sure the vertical distance of two transducers equals to the installation distance, and the two transducers are on the same axis surface. The transmit direction must be opposite.

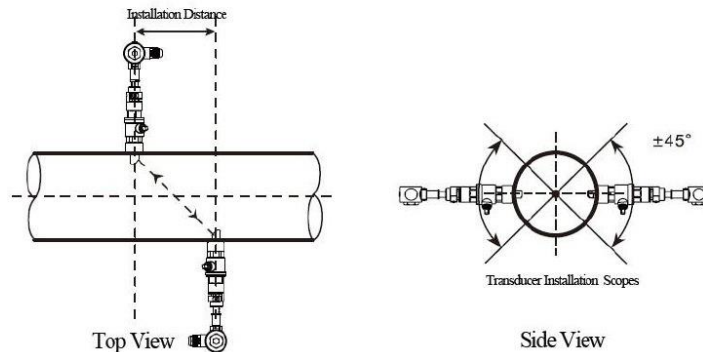

>> Parallel insertion

If there is insufficient installation space or the transducers can be only installed on the top of pipeline, parallel insertion transducer will be a good choice. (Pipe size ≥ 300)

Positioning of parallel insertion transducer need to meet the 3 factors as follow:

- Installation distance = Vertical distance of two transducers along the pipe axis direction
- Make sure two transducers are in the same horizontal line,
Insertion depth = $\frac{1}{3}$ inner diameter
- Users can set the distance between transducers by themselves. Recommend 300~500mm

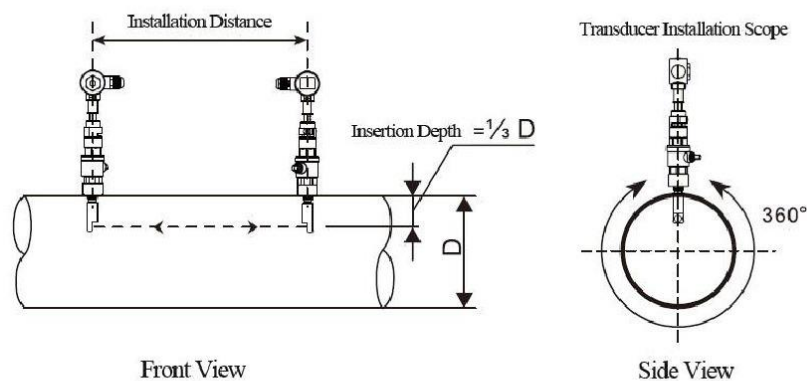

3) Positioning installation points

>> V method

The line between two transducers is parallel to pipe axis, and equal to the distance shown in the converter. As shown, A, B are the two installation points.

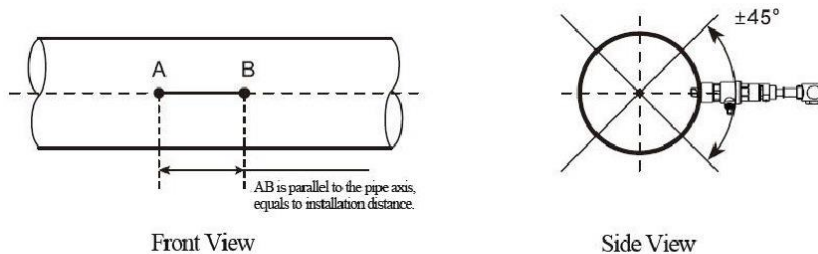

>> Z method

- ① Firstly according to the installation distance shown in converter, positioning two points A, C on the same side of pipeline. AC is parallel to pipe axis.
- ② Perpendicular to the pipe axis, opposite to point C, get Point B.
- ③ Check. Measure the length between A and B from both sides of the pipe, get AB_1 and AB_2 . If $AB_1 = AB_2$ then B is the correct point. If not, need to positioning point B and C again.

As shown, A, B are the two installation points.

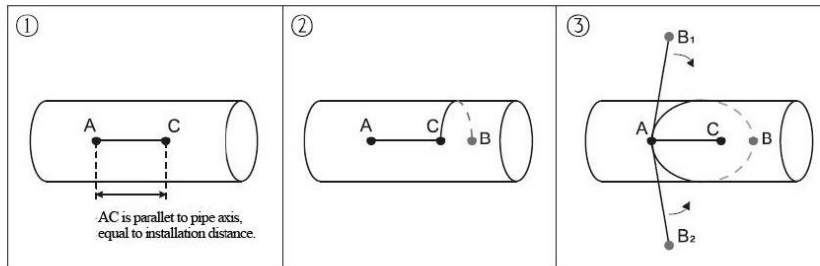

4) Fix ball valve base

>> Welding Fix

For carbon steel pipes, the ball valve base can be welded directly. Make sure that the central point of ball valve base is overlapped with the transducer installation point.

Matters need attention:

- Please take the PTFE sealing gasket out from the base before welding.
- Please clean the pipe surface around welding point before welding. Pay attention that there should not be any air hole during welding, which can avoid leaking. Welding strength must be ensured.
- Do not sputter welding slag on the base thread.
- Non-deformation of base during welding.

After welding, tighten ball valve into the base.

>> Pipe hoop Fix

For pipes can't be welded directly like cast iron pipe, cement pipe, copper pipe and composite pipe, customized pipe hoop is recommended.

The hoop center should be overlapped with the transducer installation point. Please compress the sealing gasket tightly to avoid leaking.

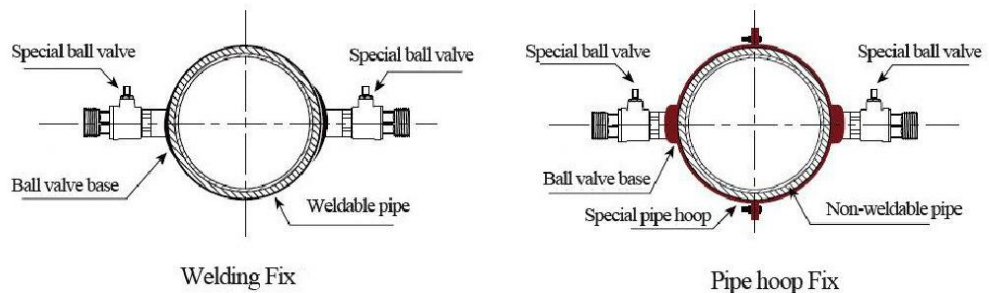

5) Open hole

After finishing the installation of ball valve and base, insert the open-hole tool into ball valve and lock it. Then open the ball valve, start drilling, from slow to fast. Close ball valve after drilling.

See more details in the video of insertion transducer installation.

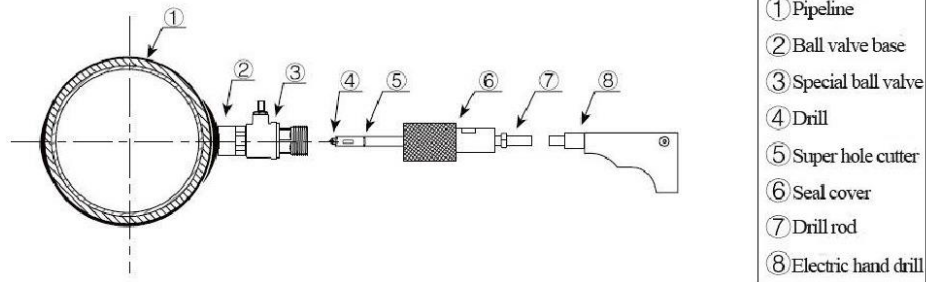

6) Install transducer and adjustment

Adjust the proper insertion depth and transmit direction to get good ultrasound signal.

>> Insertion depth adjustment

Adjust the depth scale according to pipe wall thickness, and completely push in the transducer rod.

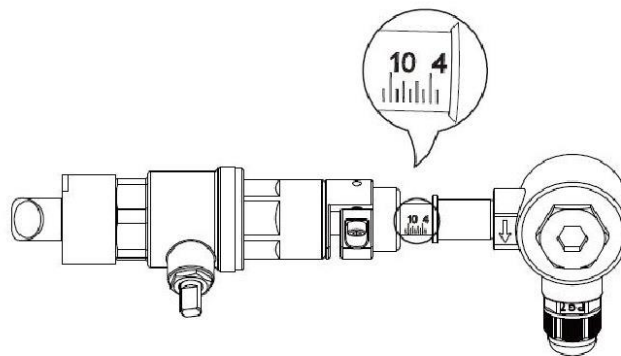

>> Transmit direction

There is a indicating arrow on the transducer junction box, the arrow direction on two transducers should be opposite " → ← " and parallel to the pipe axis.

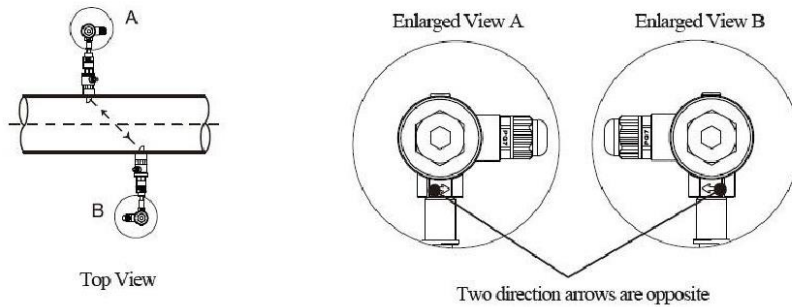

>>Operation steps

- Tighten the locknut into ball valve, adjust the insertion depth scale.
- Open ball valve, completely push in the upstream transducer rod. Adjust the transmit direction parallel with pipe axis, and point to the installation point of downstream transducer. Lock it after adjustment.
- Install downstream transducer in the same way. Adjust the transmit direction to get the best signal strength and watching Menu91, if the value is between 97% ~ 103%, the installation is correct. If not, need to re-adjust the insertion depth and transmit direction until meet the requirement.





7) Check installation

Please see details in Chapter 7.5

7.4 In-line type transducer installation

After choosing the installation point, install the transducer in the pipeline with companion flanges. Then connect the transducer to converter with special signal cable. Installation is complete.

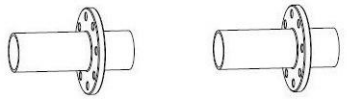
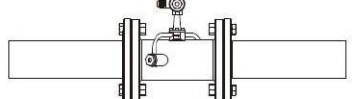
1) Installation method

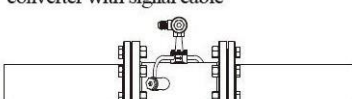
<p>① Confirm installation size</p> <p>Length of transducer $L + 2 \times \text{thickness of seal gasket} + 10\text{mm}$</p> 	<p>② Cutting pipeline</p> 
<p>③ Equip companion flanges</p> 	<p>④ Positioning the flanges</p>  <p>Twist 3 screws and averagely positioning the flanges. Fixing with spot welding.</p>
<p>⑤ Welding the flanges</p>  <p>Remove the inline transducer and full-length welding flanges.</p>	<p>⑥ As the flanges cooled, put in the seal gasket and tighten the screws. Then connect to converter with signal cable</p> 

2) Check installation

Please see details in Chapter 7.5

7.5 Check Installation

The flow meter includes the detection ability. M90 is used for checking signal strength and quality. M91 is used for checking the ratio of measured and theoretical transmission time (transmission time ratio).

1) Check signal strength and quality

M90 is used for checking the signal strength and signal quality(Q value) of upstream and downstream transducers.

Signal strength is represented by numbers 00.0 ~ 99.9, 00.0 means no signal and 99.0 means maximum signal. Generally, the flow meter can work properly when signal strength is > 60.0

Signal quality (Q value) is represented by numbers 00 ~ 99. 00 means signal is worst and 99 means signal is best. The flow meter can work properly when Q > 60.

During the installation, please adjust the transducer to make the signal strength and signal quality the larger the better. This will ensure the flow meter long term stable operation and lead to accurate measurement.

Signal strength and Q value	Installation Judgement
< 60	Can not work
60~75	Bad
75~80	Good
>80	Excellent

2) Check transmission time ratio

M91 is used for displaying transmission time ratio. It is a percentage ratio between theoretical transmission time and measured transmission time. It shows the relation between setting parameters and actual transducer installation distance. This ratio should be between 97% ~ 103%. If not in the range of 97%~103%, it means that the parameters and transducer installation distance are inconsistent. Please check separately.

8. Finish Installation

- 1) Commonly used menus. M00 or M02 is for meter reading. M30~M33 is for unit selection. M40 is for selecting damping factor, generally 5~10 sec. M60 is for correcting time and date. M26 is for curing parameters.
- 2) To avoid signal reduction and improve anti-jamming ability, it is better to use the customized signal cable from flow meter manufacturer.
- 3) The length of cables between converter and transducer should be as short as possible, cannot exceed 200m.
- 4) The temperature and humidity of working environment should be in the range of technical specifications. Avoid direct sunlight on LCD.